

Montážní nákres - LK2347bc, LK2347wh

W	D	H	A	B	C(°)	E	F
474	495	1440	792	923	130±5	50	100

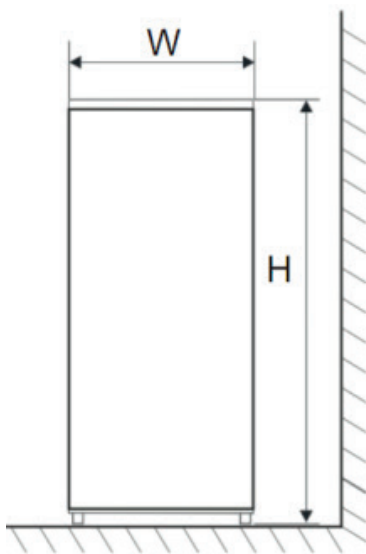

Obr. 1

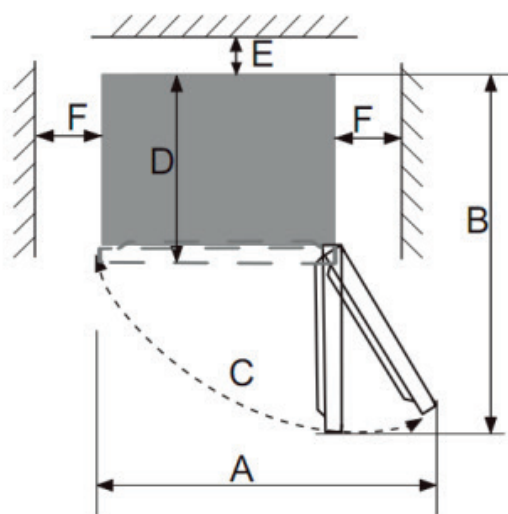

Obr. 2